

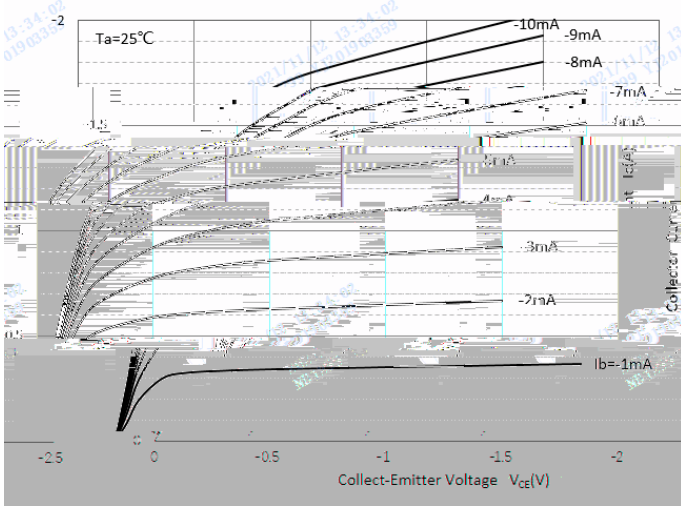

PBSS5330X

Characteristics

Static Characteristic



DC Current Gain

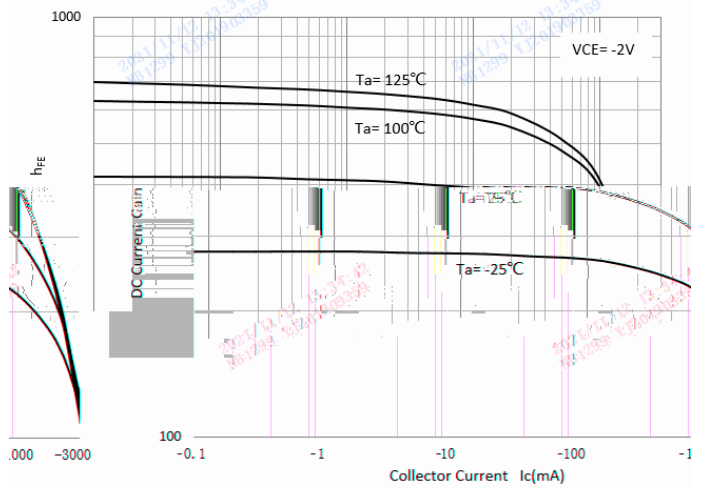

Collector-Emitter Saturation Voltage

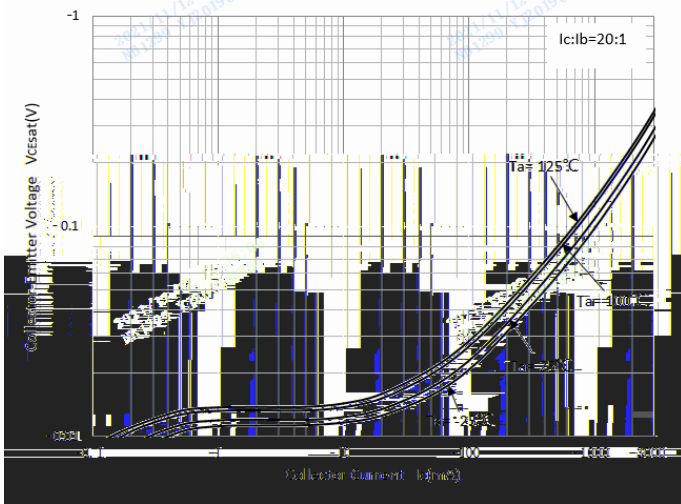

Base-Emitter Saturation Voltage

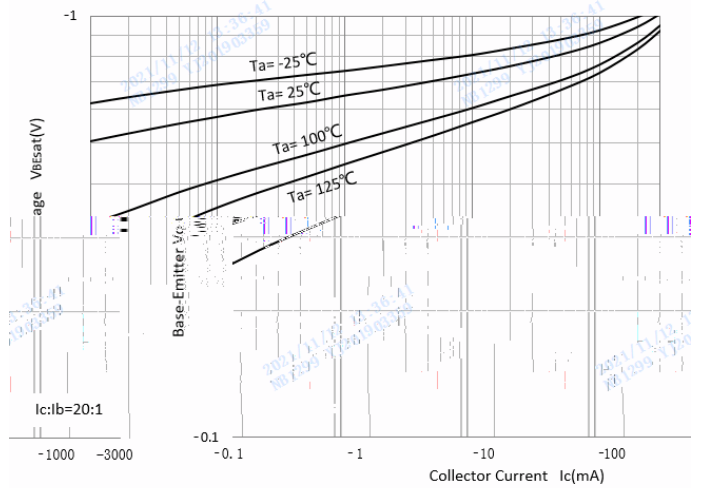

Base-Emitter On Voltage

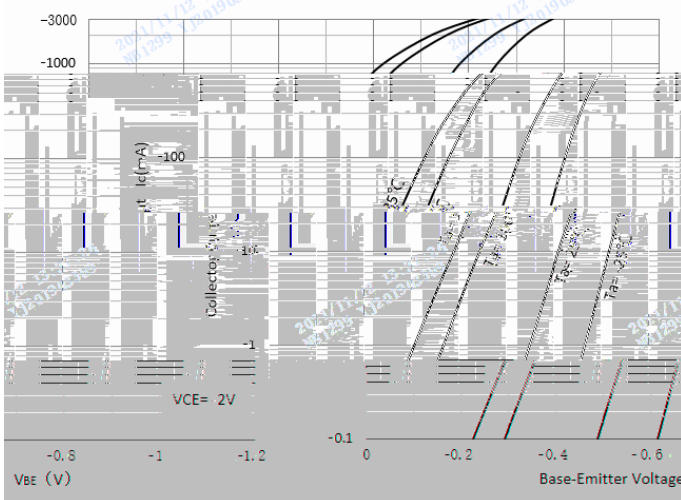

$C_{ob}/C_{ib}-V_{CE}/V_{EB}$

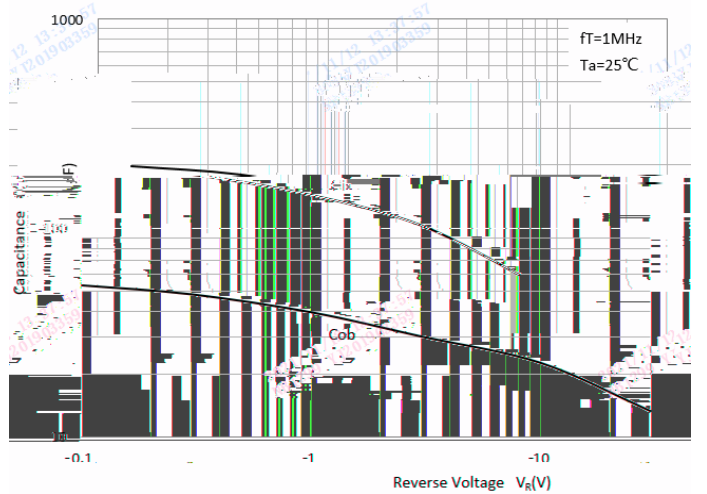



PBSS5330X

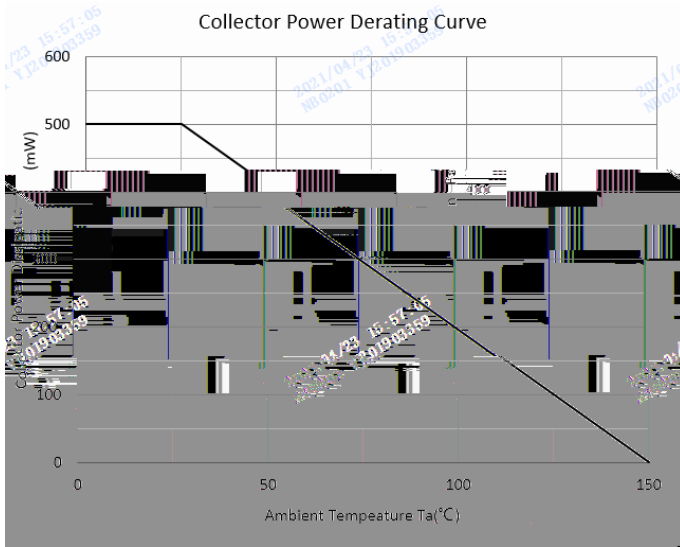

SOT-89 Package Outline Dimensions

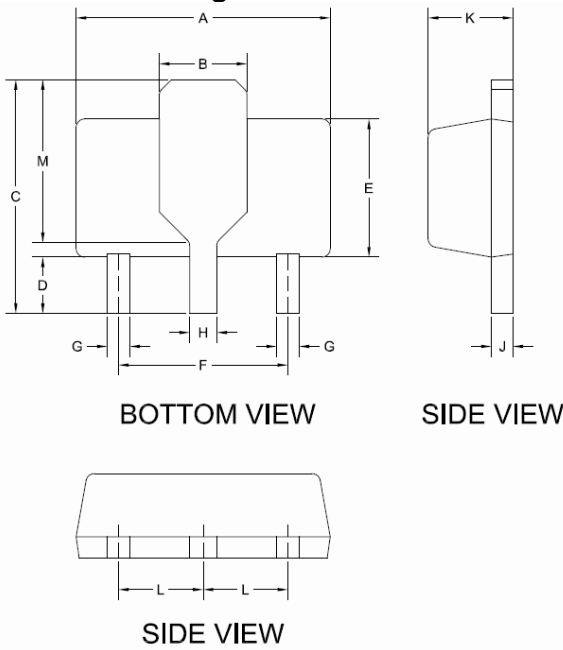

		DIMENSIONS	
		INCHES	MM
MAX.	DIM.		
4.40	4.600	A	0.173
1.550 TYP.		B	0.061 TYP.
0.940	4.250	C	0.155
0.800	2.060	D	0.047
2.400	2.500	E	0.094
3.00 TYP.		F	0.118 TYP.
0.360	0.480	G	0.014
0.440	0.560	H	0.017
	0.010	I	0.004
	0.055	J	0.006
P.		K	0.050 TYP.
YP.	M		0.108 TYP.
			500 JY
			2.750-T

SOT-89 Suggested Pad Layout

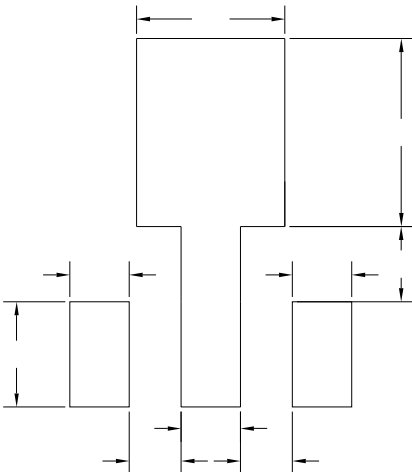



Disclaimer