

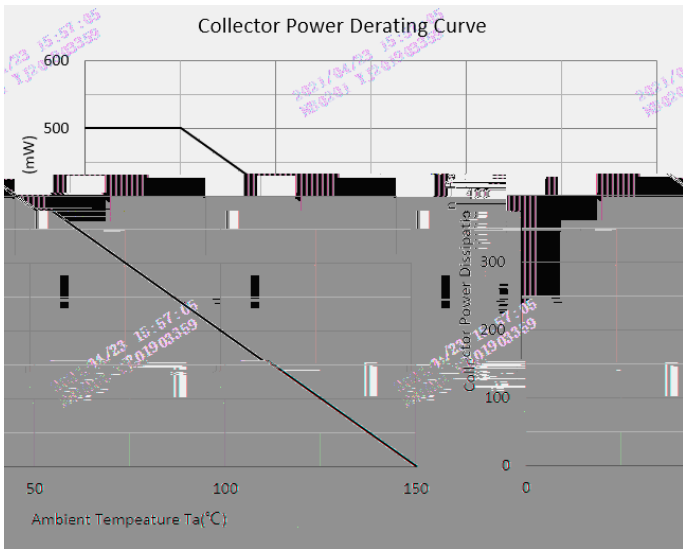

2SD1898-Q

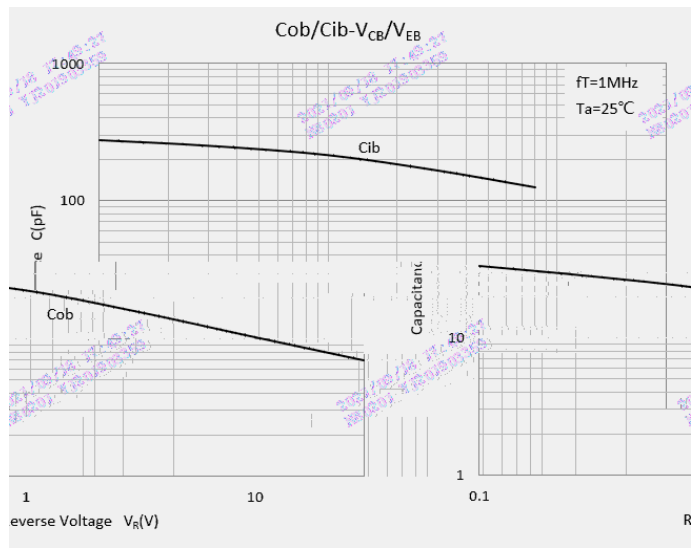

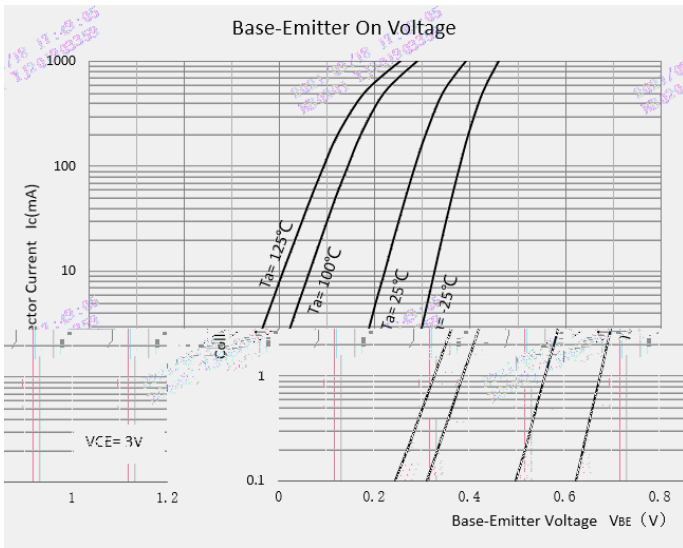
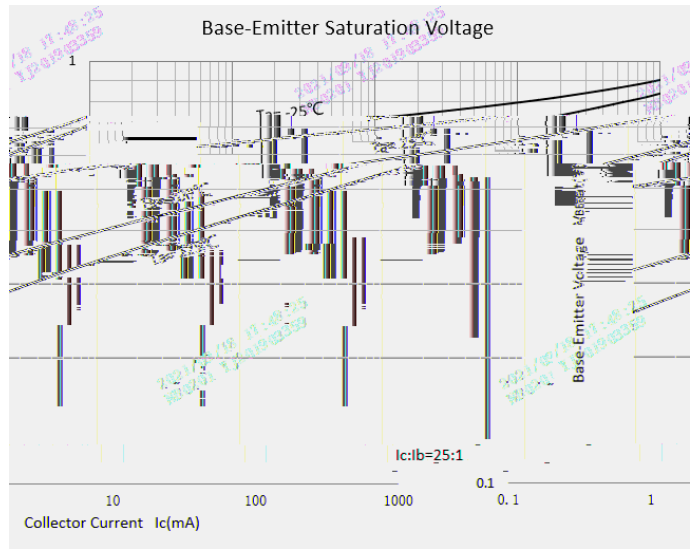
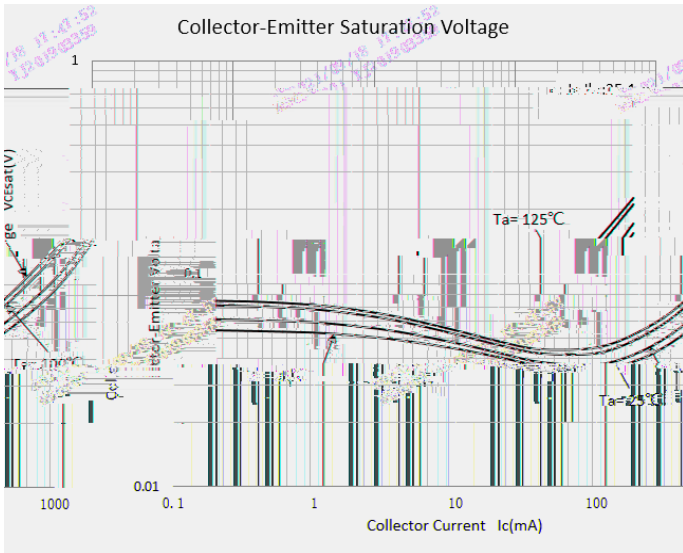

2SD1898-Q

SOT-89 Package Outline Dimensions

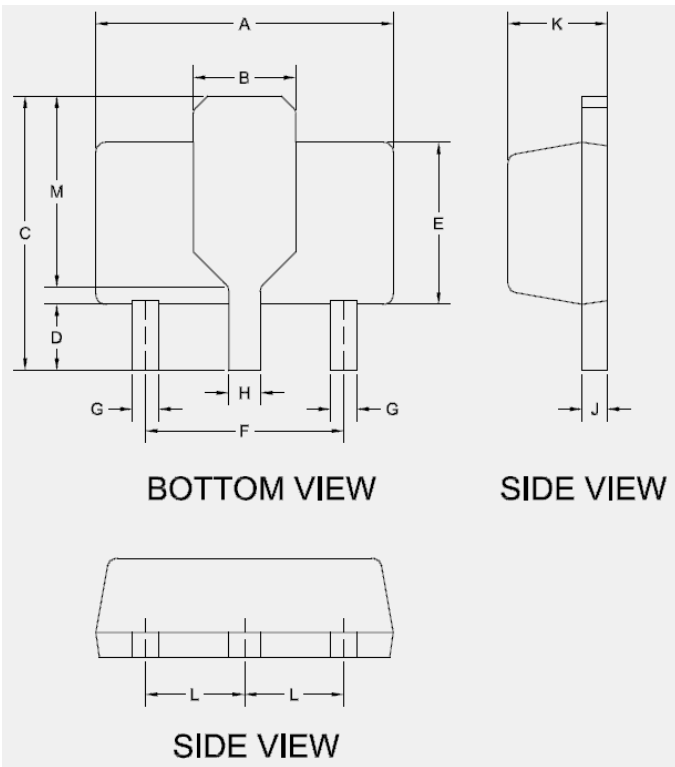

DIMENSIONS				
DIM	INCHES			
	MAX.	MIN.	MAX.	MIN.
A	4.600	0.173	0.181	4.400
B	0.061 TYP.			1.550
C	4.250	0.155	0.167	3.940
D	1.200	0.031	0.047	0.800
E	2.600	0.094	0.102	2.400
F	0.118 TYP.			3.000
G	0.480	0.014	0.019	0.360
H	0.560		0.017	0.022
J	0.350	0.440	0.014	0.017
K	1.400	1.600	0.055	0.063
M	2.750 TYP.			0.108 TYP.

SOT-89 Suggested Pad Layout

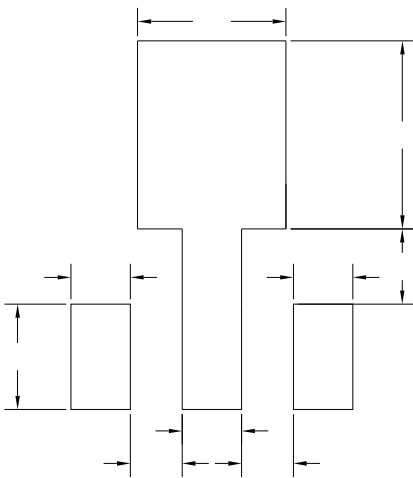



Disclaimer